

ALON

이동식 책꽂이 3단 H20666

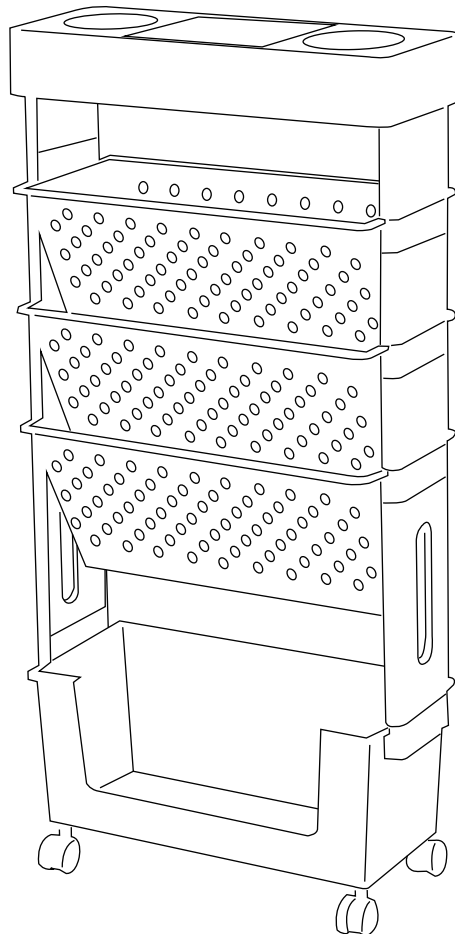

[취급주의]

- 가구사용시 인위적으로 휘발성있는 물질을 흘렸을 경우 가구표면의 손상이 발생하오니 주의하세요.
- 무리한 힘이나 충격을 가하지 마시고 수평을 유지하여 사용하세요.
- 직사광선이나 강한열 혹은 촉한을 피해주세요.
- 이동시 끌지마시고 들어서 이동하여 주세요.
- 테이프나 접착용품은 제품에 훼손을 일으킬수 있으니 주의하세요.
- 교환/취소/반품/환불 관련사항은 사이트 참조바랍니다.

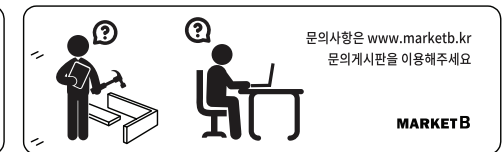
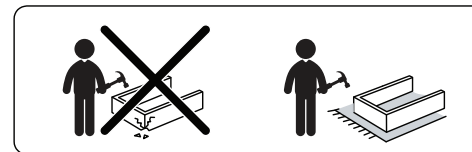

TIP

조립전 부품의 이상유무를 반드시 확인해주세요.

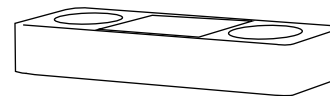

Ax1



Bx6

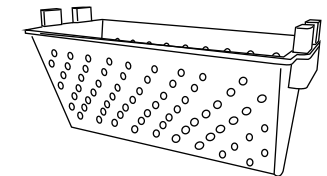

Cx3



Dx2

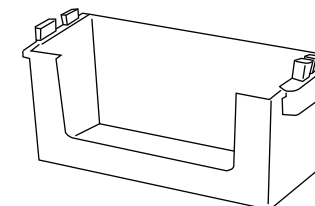

Ex1



Fx4

1

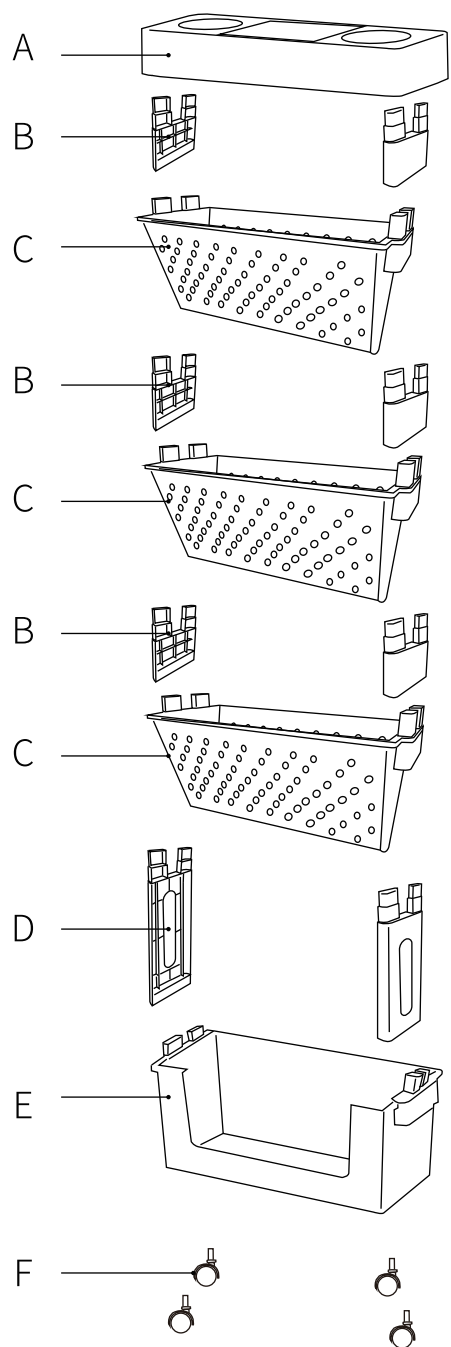

2

